

# YBS Insulation

HIGH QUALITY PRODUCTS FOR THE BUILDING INDUSTRY

CI/SfB (47) Rn7



CERTIFICATE NUMBER 033/96

(Therma-Close)

## TYPE-R FIRE-STOP

FIRE RETARDANT RIGID CAVITY CLOSER SYSTEM

PATENT PENDING



NOW AVAILABLE FOR CHECK REVEALS

OVER 60mins  
FIRE INTEGRITY

Warrington  
FIRE  
research

Test Certificate No. 136524

Manufactured in UK and made to a Quality System meeting the requirements of BS EN ISO 9002



Meets New Robust Details

NHBC Approved

Fully Certified

(Therma-Close)

## TYPE-R

RIGID GENERAL PURPOSE CAVITY CLOSER SYSTEM



NOW AVAILABLE FOR CHECK REVEALS

Fully Rigid Plastic Cavity Closer

Unique Secondary Water Seal for Frames

Ties in to both Leaves



[www.ybsinsulation.com](http://www.ybsinsulation.com)

**PLEASE SPECIFY:  
Insulated Cavity  
Closer to be:**

**YBS TYPE-R**

Length: 2.5m  
1.2m

**YBS TYPE-**

**Fire-Stop**  
Length:

Cavity Width: XXXmm  
By: YBS Insulation

(Therma-Close) **TYPE-R** and **Type-R Fire-Stop** are specially designed to create a more rigid waterproof cavity closer system.

**TYPE-R** and **Type-R Fire-Stop** comprise two rigid extensions, one of which has a unique, flexible, water seal. Once the window is in place the flexible seal sits against the window frame and acts as a secondary water seal.

These two rigid extensions allow **TYPE-R** and **Type-R Fire-Stop** to be made to any cavity width. **TYPE-R** and **Type-R Fire-Stop** are now available for both standard and check reveals to suit Robust Details.

**GWP Below 5  
ODP Below 5**

Manufactured in UK and made to a Quality System meeting the requirements of BS EN ISO 9002



(Therma-Close)

**TYPE-R**

**FIRE-STOP**

**FIRE RETARDANT RIGID CAVITY CLOSER SYSTEM**

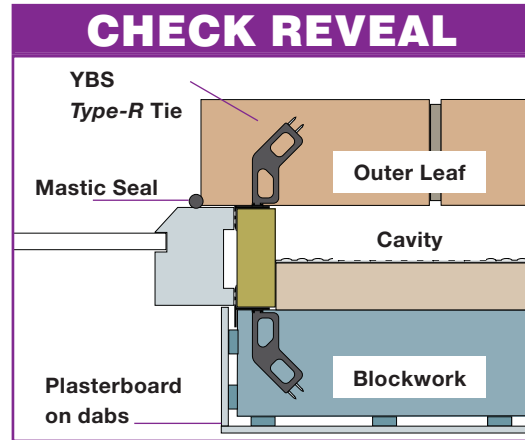
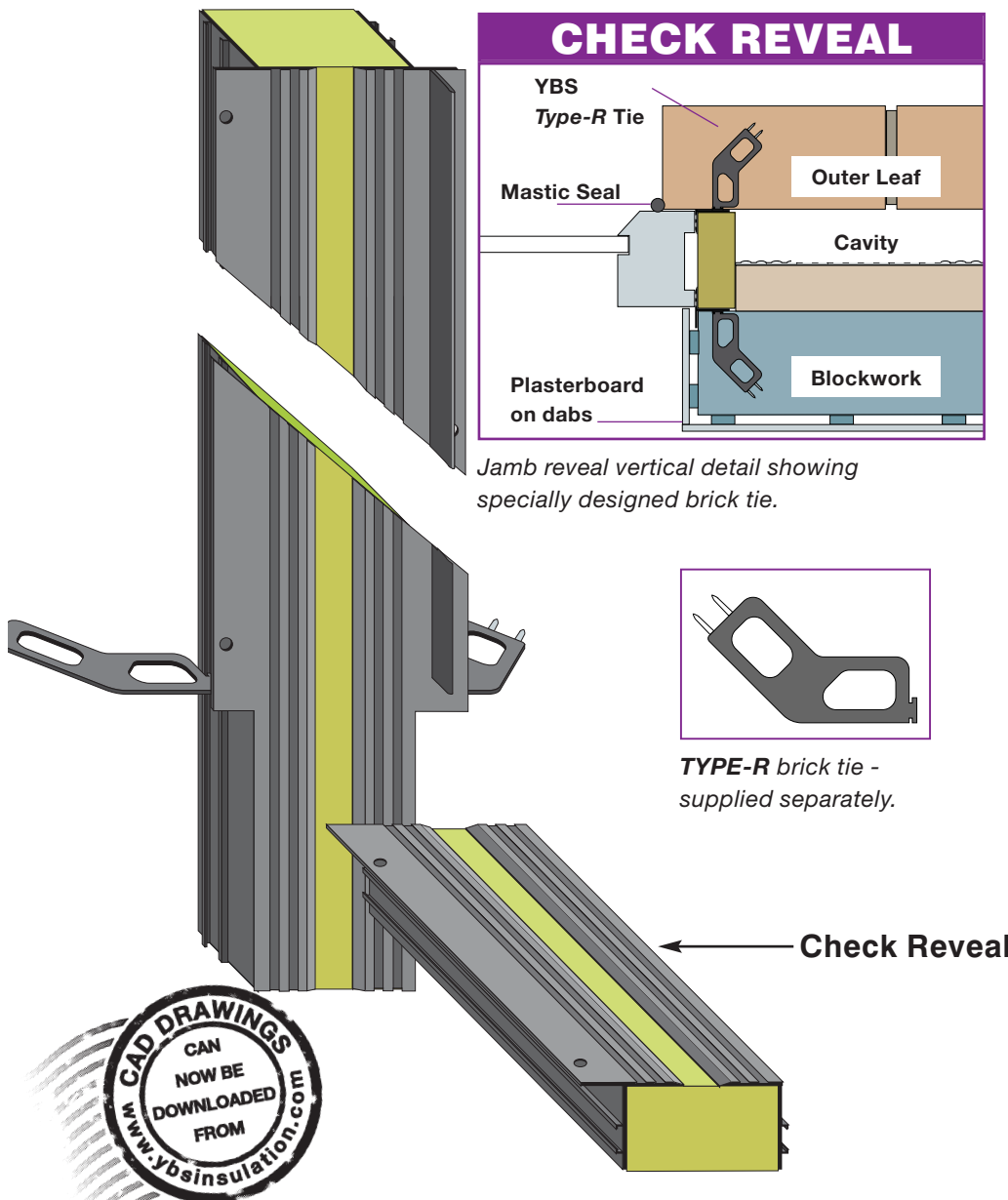

Jamb reveal vertical detail showing specially designed brick tie.

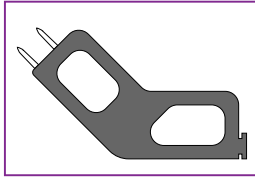

TYPE-R brick tie - supplied separately.

- ### Features
- Waterproofing, Insulating and Self Locating in one fully assembled piece.
  - **TYPE-R's** unique design incorporates a **flexible water seal** which reduces the possibility of water penetration. (in robust detail)
  - Robust, easy to use on-site and can be cut to size and jointed, minimising waste.
  - Eliminates the need for blockwork to close the cavity.
  - Both are **CFC & HCFC Free** - kind to the environment.

**OVER 60mins  
FIRE INTEGRITY**



Test Certificate No. 136524



**(Therma-Close) TYPE-R Fire-Stop** is supplied in 1.2m lengths and can be supplied to suit any cavity width.  
**TYPE-R Fire-Stop** is available for Robust and Check Reveals

**COMPREHENSIVE FIXING DETAILS ARE AVAILABLE UPON REQUEST**

**YBS TYPE-R** and **TYPE-R Fire-Stop** ties are also available to enable, if required, the closer to be built into both leaves. **TYPE-R** and **TYPE-R Fire-Stop** is designed to be used in door thresholds and both jambs and cills of windows, this provides a total solution to cold bridging problems associated with openings in traditional cavity wall construction.

Continual demand for greater thermal efficiency has lead to the reduction of the 'U' value requirements of structures, emphasised in the recent revision of Building Regulations (L1 & L2) and Building Standards Part J. **TYPE-R** and **TYPE-R Fire-Stop** are designed to offer the perfect solution for the specifier to satisfy this requirement.

**The only rigid Cavity Closer available which creates a secondary water seal by use of a flexible strip. OR available for check reveal detail.**

# (Therma-Close) TYPE-R

**RIGID GENERAL PURPOSE CAVITY CLOSER SYSTEM**

## Type-R can be installed in a variety of ways:

- Tack to window frame if built-in
- Built-in as work progresses using special ties (see fig. 2)
- **TYPE-R** can be installed after the reveal has been constructed by fixing to the inner leaf using holes provided.

## Vertical Jointing

If required, sections of (Therma-Close) **TYPE-R** can be jointed to minimise waste. All joints must be tightly butted - 45° downwards towards the outer leaf. This will stop potential water penetration.

## Corner Jointing

When jointing horizontal to vertical, trim both PCV flanges and allow the vertical to extend below the horizontal - this stops water ingress (see fig. 1).

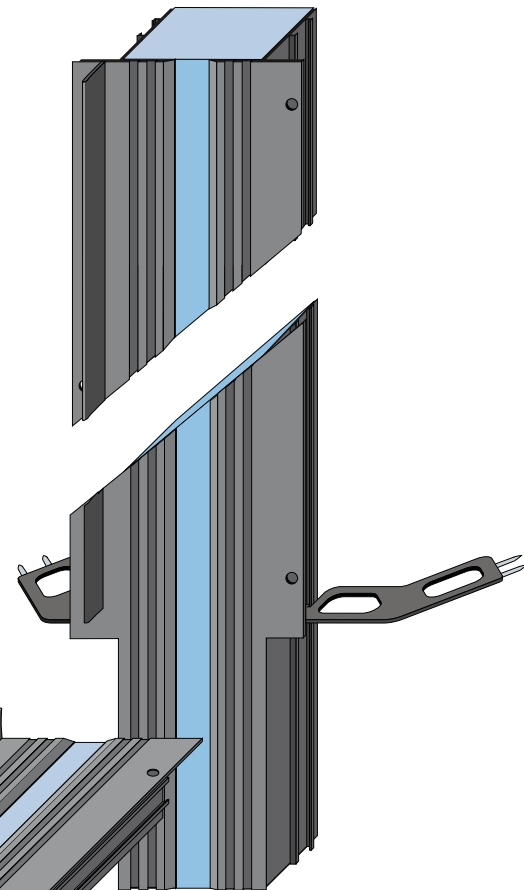

Horizontal to vertical jointing. Fig. 1

NB: The vertical section extends into the cavity.

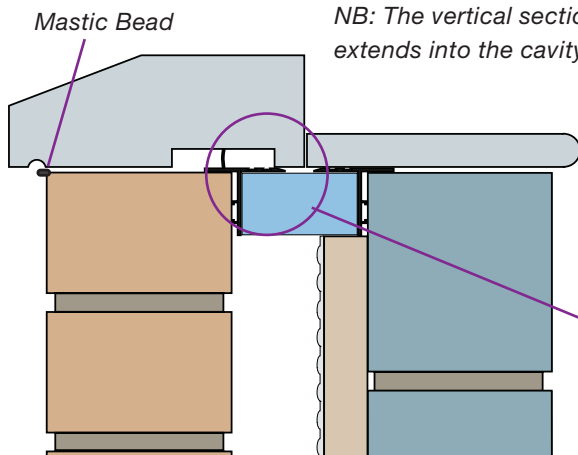

This detail shows how the flexible seal would prevent further water ingress if the mastic seal failed.

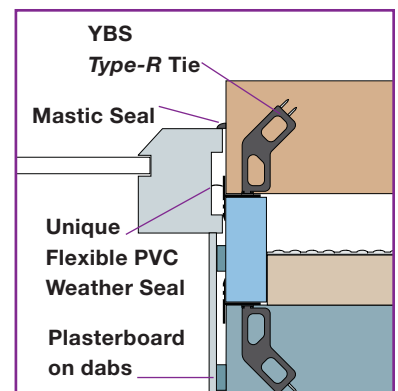
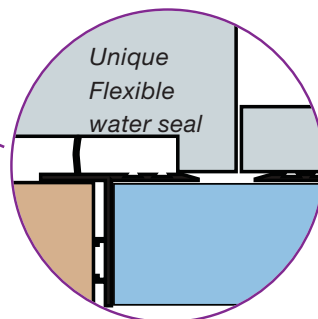
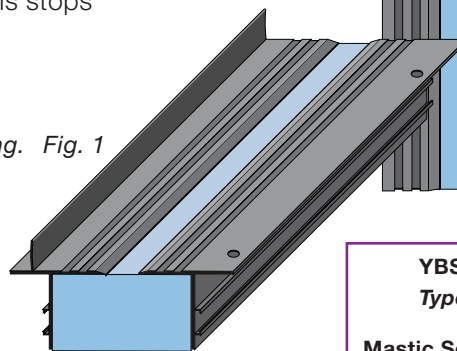

Jamb reveal vertical detail showing specially designed brick tie.

**(Therma-Close) TYPE-R is supplied in 2.5m lengths and can be supplied to suit any cavity width. (Therma-Close) TYPE-R is available for Robust and Check Reveals**

**For technical advice and support please call:**

tel: 0844 99 100 44

e-mail: [sales@ybsinsulation.com](mailto:sales@ybsinsulation.com) or fax: 0844 99 100 55

Manufactured in UK and made to a Quality System meeting the requirements of BS EN ISO 9002



# Technical Data

## TOLERANCE

ALL FINISHED INSULATION SIZE TO HAVE A TOLERANCE OF -4MM TO +0MM TO SUIT VARYING CAVITY SIZES

## Calculation method for assessing Thermal Bridging at the edges of openings.

The diagrams below shows a window jamb in a masonry cavity wall, with **Type-R** and **Type-R Fire-Stop** closing the cavity. Robust details require a cavity closer with a minimum Thermal Resistance Path of 0.45m<sup>2</sup>K/W.

### Example of Thermal Resistance for

## Type-R Fire-Stop Check Reveal

This table shows the thermal resistance for each segment of the path ABC. The thermal resistance for each segment is obtained by dividing the length of the path segment in metres by its thermal conductivity in W/mK.

Path Segments	Length (m)	Conductivity (W/mK)	Resistance (m <sup>2</sup> K/W)
A-B	0.0275	0.12	0.23
B-C	0.065	0.034	1.192
<b>Thermal Resistance Path ('R' value) = 2.142m<sup>2</sup>K/W</b>			

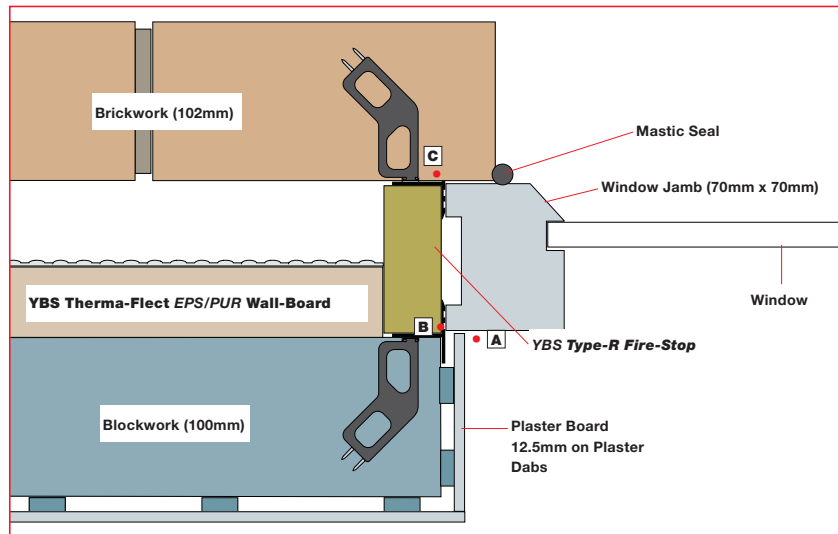

### Technical References

Building Regulations 2000  
Approved Document L1 + L2.

BRE publication  
"Thermal Insulation: Avoiding the risks".

TSO Publication: Limiting Thermal Bridging and Air Leakage : Robust Construction Details for Dwellings and Similar Buildings

BRE Scotland:  
Conventions for U Value Calculations

### Example of Thermal Resistance for

## Type-R Robust Details

This table shows the thermal resistance for each segment of the path ABCD. The thermal resistance for each segment is obtained by dividing the length of the path segment in metres by its thermal conductivity in W/mK.

Path Segments	Length (m)	Conductivity (W/mK)	Resistance (m <sup>2</sup> K/W)
A-B	0.0275	0.12	0.23
B-C	0.025	0.029	0.862
C-D	0.040	0.770	0.052
<b>Thermal Resistance Path ('R' value) = 1.144m<sup>2</sup>K/W</b>			

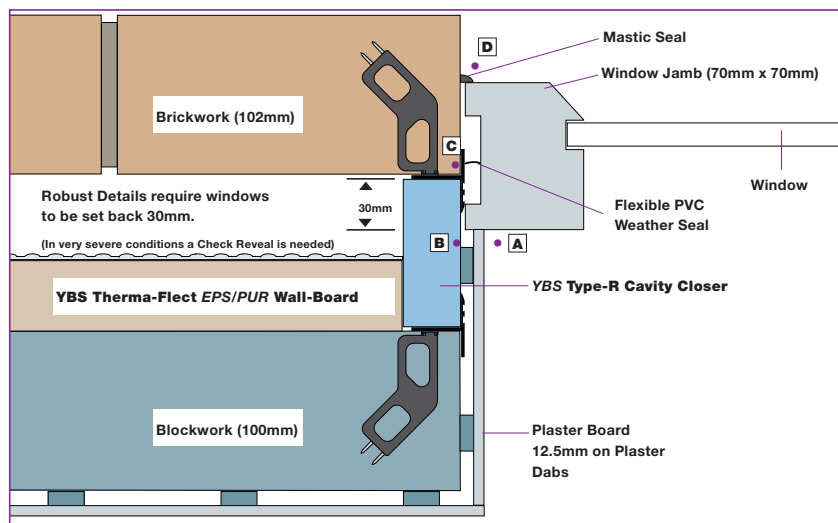

### Yorkshire Building Services (WHITWELL) Ltd.

Crags Industrial Park, Morven Street, Creswell, Derbyshire S80 4AJ

Tel: 0844 99 100 44

Fax: 0844 99 100 55

[sales@ybsinsulation.com](mailto:sales@ybsinsulation.com) [www.ybsinsulation.com](http://www.ybsinsulation.com)

YBS 175 V3 (03/2010)